



melogranoblu

SYSTEMS

## LEGEND



CLEAR GLASS



FROSTED GLASS



RULED CLEAR GLASS



RULED FROSTED GLASS



METALLIZED RULED GLASS



METALLIZED



INNER LIGHT



REFLECTED LIGHT



SUSPENSION LAMP

## INDEX

|                            |     |
|----------------------------|-----|
| <b>NOVA SYSTEM</b>         |     |
| NOVA GLASSES               | 14  |
| STROMBOLI & STROMBOLICCHIO | 16  |
| JANUS                      | 20  |
| BLEND A ORIZONTAL          | 22  |
| BLENTA VERTICAL            | 26  |
| GALENA                     | 32  |
| <b>HYDRA SYSTEM</b>        |     |
| COMPONENTS                 | 56  |
| HYDRA GLASSES              | 60  |
| ACORN                      | 62  |
| ALPHA                      | 64  |
| ACQUA                      | 66  |
| AVATAR                     | 68  |
| BERRY                      | 70  |
| BERRY METAL                | 72  |
| BETA                       | 76  |
| DATURA                     | 78  |
| DELTA                      | 80  |
| DERVISCI                   | 82  |
| DIESIS                     | 84  |
| GAMMA                      | 86  |
| LAMBDA                     | 90  |
| LHASA                      | 92  |
| OMEGA                      | 94  |
| ONION                      | 98  |
| ORGANIC                    | 100 |
| SIGMA                      | 102 |

## THE FACTORY OF EMOTIONS

CONCEIVED AND FOUNDED IN 1997 BY ERMANNOCCHI AND MASSIMO CREMA, MELOGRANOBLU IS AN ITALIAN INTERIOR LIGHTING COMPANY. OVER THE YEARS, THE COMPANY HAS DEVELOPED A WIDE RANGE OF SOLUTIONS FOR INTERIOR LIGHTING DESIGN, SUITABLE FOR HOMES OR OFFERING MORE IMPRESSIVE INSTALLATIONS FOR LARGE ARCHITECTURAL SETTINGS.

MELOGRANOBLU CREATIONS ARE VERITABLE SPECTACLES OF LIGHT, FOCUSING ON THE SENSORY AND EMOTIONAL EFFECT OF LIGHT THROUGH GLASS.

DESIGN PROJECTS IN WHICH ALL FORMS OF GLASS ARE CONCEIVED AND DESIGNED ACCORDING TO THE EFFECTS THEY CAN GENERATE THROUGH LIGHT.

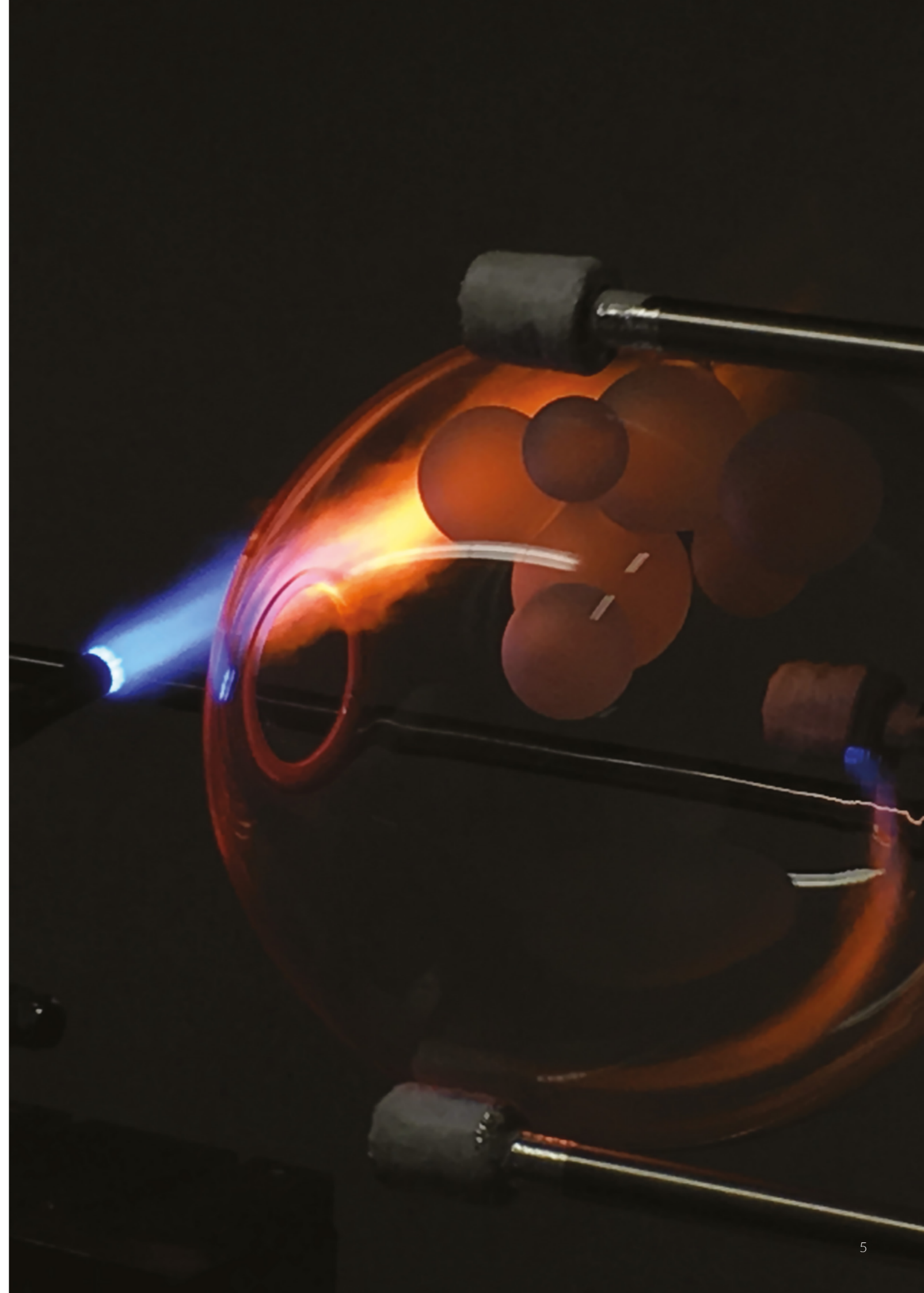

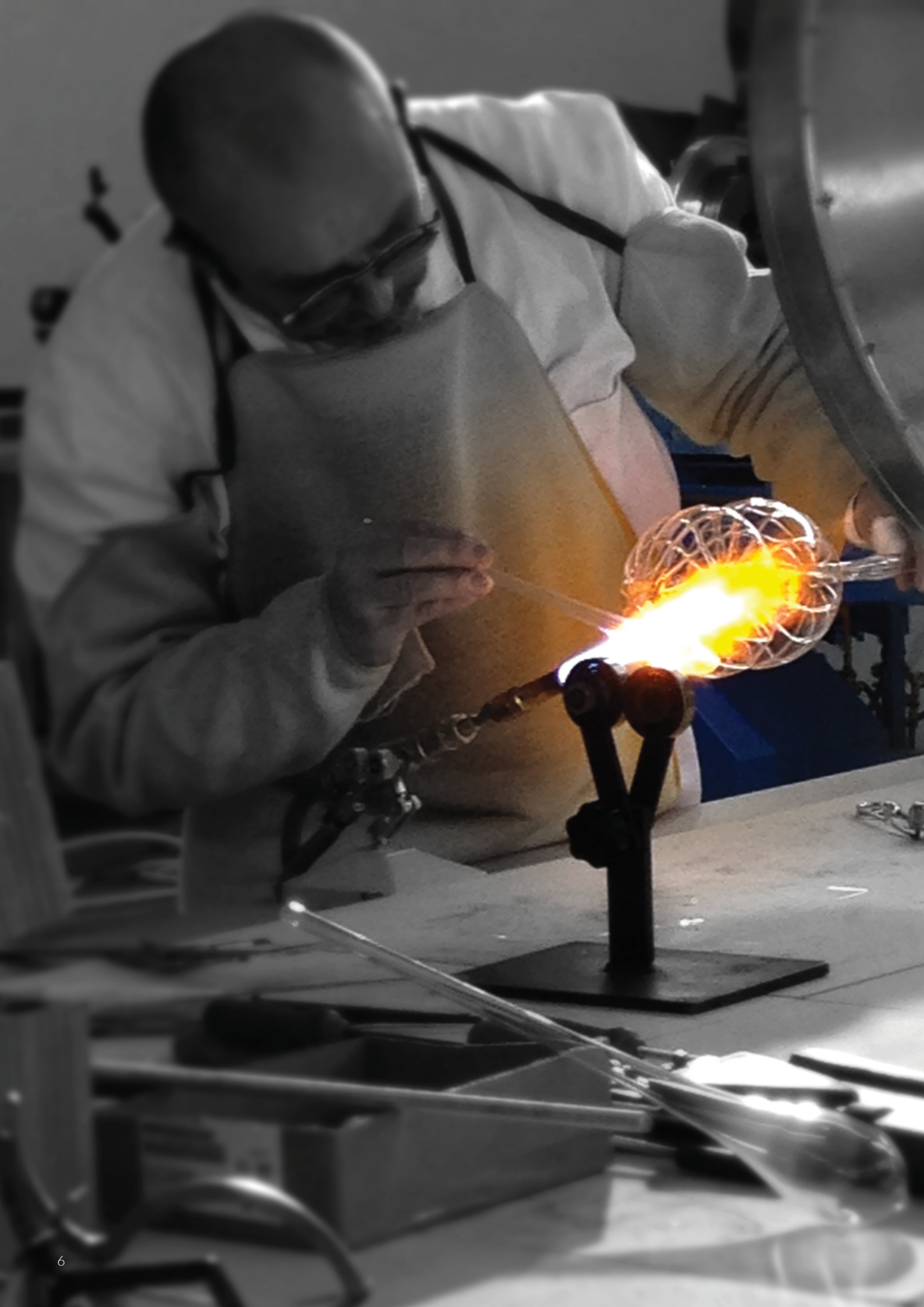

## CRAFTED PRODUCTION AND INDUSTRIAL ORGANISATION

EVERY MELOGRANOBLU PROJECT IS CONCEIVED, DEVELOPED, ENGINEERED AND PRODUCED WITHIN THE COMPANY. AN ORGANIZED STRUCTURE TO MANAGE AND GUARANTEE 'MADE IN ITALY' QUALITY THROUGHOUT THE ENTIRE PRODUCTION PROCESS.

IN THE PRODUCTION LABORATORY, THE PIECES ARE BLOWN AND WORKED BY HAND. MULTIPLES OF ART, EQUAL BUT ALWAYS DIFFERENT BECAUSE THEY ARE MADE ONE BY ONE.

THE SURFACE FINISHES OF OUR GLASS ARE HANDCRAFTED USING THE METALLIZATION TECHNIQUE, A TREATMENT OBTAINED BY SUBLIMATING AND CONDENSING A LAYER OF METAL.

ANY VARIATIONS IN COLOR, TEXTURE OR SLIGHT IMPERFECTIONS ARE UNAVOIDABLE AND TO BE CONSIDERED DISTINCTIVE CHARACTERISTICS OF HANDCRAFTED PRODUCTS AS A GUARANTEE OF THEIR UNIQUENESS.

MELOGRANOBLU RESERVES AND GUARANTEES CAREFUL QUALITY CONTROL.

## MADE-TO-ORDER

MELOGRANOBLU'S IN-HOUSE GROUP OF DESIGNERS WORKS IN COLLABORATION WITH THE CLIENT, DEVELOPING EACH SPECIFIC DESIGN IDEA TO ACHIEVE A MADE-TO-MEASURE LIGHT INSTALLATION.

MELOGRANOBLU MADE-TO-ORDER DESIGNS, ALL DEVELOPED AND ENGINEERED WITHIN THE COMPANY, ARE DELIVERED TO THE CLIENT COMPLETE WITH DETAILED INSTRUCTIONS TO GUIDE EASY INSTALLATION IN TOTAL SAFETY.



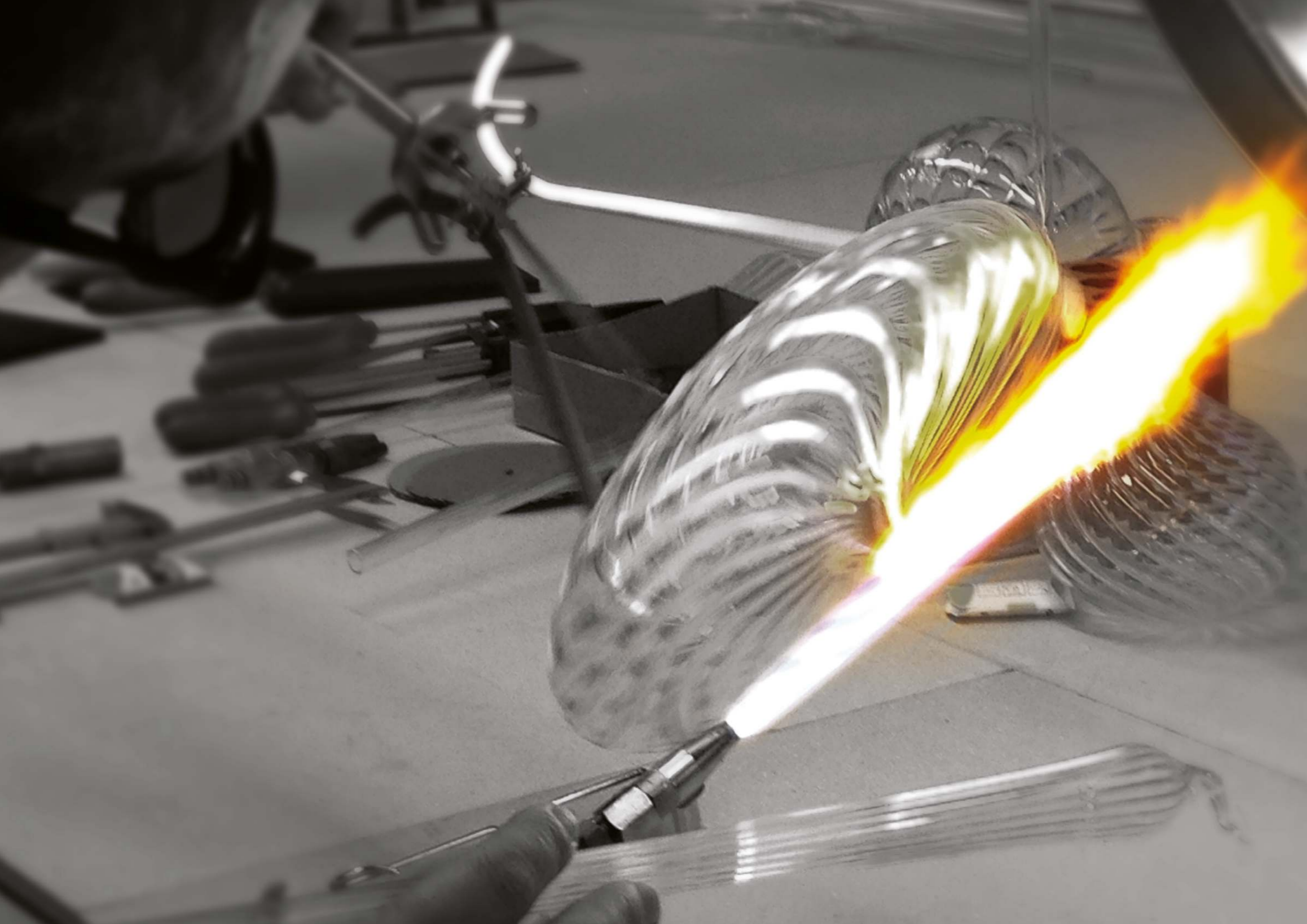



## NOVA SYSTEM

NOVA PRESENTS AN EXCLUSIVE SELECTION OF BLOWN GLASS PENDANTS, EACH A MASTERPIECE OF DESIGN CONCEIVED TO EMBELLISH SPACES WITH STYLE AND SOPHISTICATION, EITHER INDIVIDUALLY OR IN SCENOGRAPHIC COMPOSITIONS.

EACH PENDANT IS EQUIPPED WITH AN INTEGRATED LIGHT SOURCE AND REPRESENTS EXCELLENT CRAFTSMANSHIP THAT GUARANTEES INCOMPARABLE QUALITY. NOVA CELEBRATES THE ART OF LIGHTING WITH TIMELESS ELEGANCE.

SIX DESIGNS ARE AVAILABLE: STROMBOLI AND STROMBOLICCHIO, JANUS, BLEND A HORIZONTAL, BLEND A VERTICAL, GALENA HORIZONTAL AND GALENA VERTICAL, EACH IN DIFFERENT SIZES AND FINISHES.



NOVA SYSTEM

## GLASSES

- 1 STROMBOLI & STROMBOLICCHIO page 16
- 2 JANUS page 20
- 3 BLEND A ORIZONTAL page 22
- 4 BLEND A VERTICAL page 26
- 5 GALENA page 32

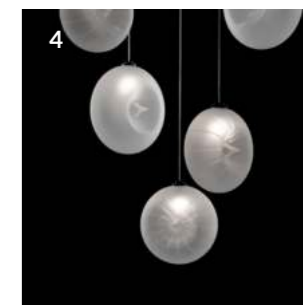



NOVA

# STROMBOLI & STROMBOLICCHIO



HAND-BLOWN GLASS SHAPE CLEAR

Glass dimension:  
Stromboli h. 15cm, ø 13 cm.  
Strombolicchio h 10 cm., ø 15 cm.  
Light source: G4 LED bulb 12 Volt, 2700k.  
Metal parts in nickel finishing.  
Electric coaxial cable 15 mt length maximum

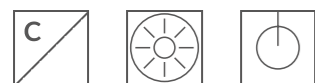



NOVA

# JANUS



HAND-BLOWN RULED GLASS SHAPE

CLEAR, FROSTED OR METALLIZED FINISH AVAILABLE

Glass dimension:  $\varnothing$  16 cm.

Light source: G4 LED bulb 12 Volt, 2700k.

Metal parts in nickel finishing.

Electric coaxial cable 15 mt length maximum



NOVA

# BLEND ORIZONTAL



HAND-BLOWN RULED GLASS SHAPE  
CLEAR OR FROSTED FINISH AVAILABLE

Glass dimension:  
Large h. 10cm, ø 21,5 cm.  
Small h 9 cm., ø 18,5 cm.  
Light source: G4 LED bulb 12 Volt, 2700k  
Metal parts in nickel finishing  
Electric coaxial cable 15 mt length maximum





NOVA

# BLEND VERTICAL



HAND-BLOWN RULED GLASS SHAPE  
CLEAR OR FROSTED FINISH AVAILABLE

Glass dimension:  
Large h. 10cm, ø 21,5 cm.  
Small h 9 cm., ø 18,5 cm.  
Light source: G4 LED bulb 12 Volt, 2700k  
Metal parts in nickel finishing  
Electric coaxial cable 15 mt length maximum





WHEN LIGHT MEETS  
REFINED DESIGN.





NOVA

# GALENA



HAND-BLOWN RULED GLASS SHAPE

CLEAR, FROSTED OR METALLIZED FINISH AVAILABLE

Glass dimension

Large l. 9 cm, ø 17 cm.

Small l. 8 cm., ø 14 cm.

Light source: G4 LED bulb 12 Volt, 2700k

Metal parts in nickel finishing







## HYDRA SYSTEM

HYDRA IS A MODULAR LIGHTING SYSTEM FOR INTERIORS CREATED BY MELOGRANOBLU FOR DESIGNING AND CREATING ALLURING AND SOPHISTICATED LIGHTING COMPOSITIONS WITH GREAT EASE.

SHAPES IN BLOWN GLASS, CLEAR OR FROSTED, SUSPENDED USING COLOURED TUBULAR METAL LINKS, REFLECT THE LIGHT IN THE ROOM TO CREATE EVOCATIVE ATMOSPHERES.

VERSATILITY, LIGHTNESS, EASY INSTALLATION AND FREEDOM OF DESIGN ARE ITS DISTINCTIVE FEATURES.

WITH HYDRA YOU CAN CREATE COUNTLESS LIGHT CONFIGURATIONS SUITED TO ALL ARCHITECTURAL INTERIORS, BE THEY RESIDENTIAL OR CONTRACT.

THE IN-HOUSE GROUP OF DESIGNERS WORKS IN CLOSE SYNERGY WITH THE CLIENT IN CREATING SPECTACULAR COMPOSITIONS STUDIED FOR THE SPECIFIC INTERIOR DESIGN PROJECT. STARTING OUT WITH A CONCEPT, IT DEVELOPS A DETAILED SHOP DRAWING COMPLETE WITH INSTALLATION INSTRUCTIONS.



LIGHT CREATES  
EVOCATIVE  
ATMOSPHERES







VERSATILITY  
AND FREEDOM  
OF DESIGN









PRECIOUS  
DETAILS.



TIMELESS  
LIGHTING  
SOLUTIONS





HYDRA SYSTEM

## COMPONENTS

**A** LIGHT SOURCE  
See page 34

**B** FIXING ACCESSORIES  
See page 35

**C** METALLIC MESH ROPES  
See page 35

**D** GLASSES  
See page 36

## A LIGHT SOURCE

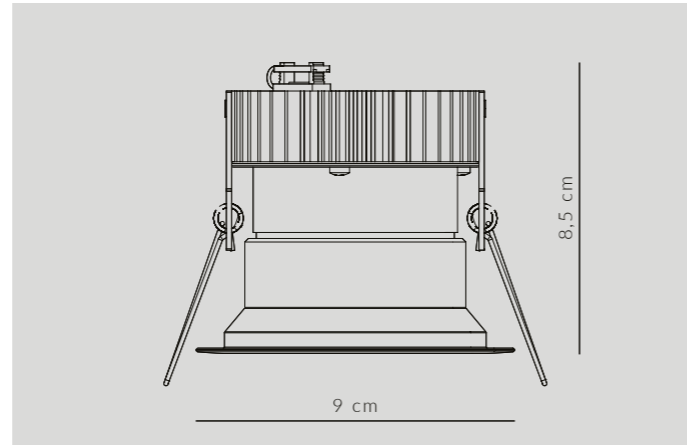

LED recessed projector 10W24Vdc 2700k cri93 optics 6° circular body ø 90 mm.

Hydra System is also customizable with: LED CEILING LIGHT (See page 80) or INNER LIGHTS.

## INNER LIGHTS

METALLIC MESH ROPE CAN BE ELECTRIFIED, TO HAVE LIGHT INSIDE GLASSES.

- ① Special fixing support for false ceiling.
- ② Inner light for Hydra System glasses complete with special G4 pin LED bulb 2,5 W melogranoblu patent.

Additional inner light can be used only with following models: Alpha, Berry metal, Beta, Datura, Delta, Diesis, Gamma① .

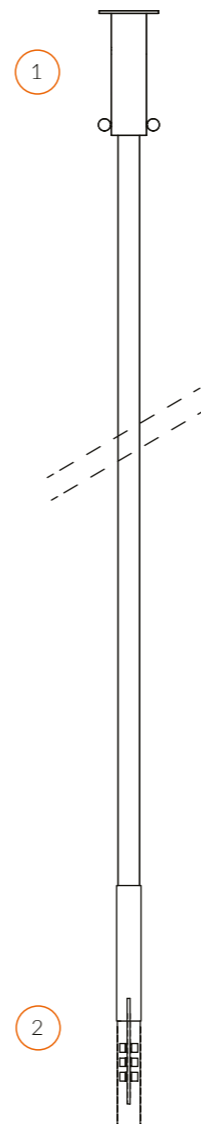

## B FIXING ACCESSORIES



CEILING FIXING SUPPORT



FLOOR FIXING SUPPORT



GLASS FIXING METAL PIN

## C METALLIC MESH ROPES

#T11 Red

#T34 Fuxia

#T39 Orange

#T26 Gold

#T36 Purple

#T35 Wistaria

#T12 China Blue

#T29 Turquoise

#T08 Titanium

#T00 Copper

#T20 Brown

#T07 Silver

#T21 Black



COLOURED METALLIC MESH ROPE TO HANG GLASSES.

Colors in this catalogue may lightly vary because of printing. melogranoblu reserve the right to modify products and colors, without notice, in order to make technical improvements.

# D GLASSES

- 1 ACORN page 62
- 2 ALPHA page 64
- 3 ACQUA page 66
- 4 AVATAR page 68
- 5 BERRY page 70 | BERRY METAL page 72
- 6 BETA page 76
- 7 DATURA page 78
- 8 DELTA page 80
- 9 DERVISCI page 82
- 10 DIESIS page 84
- 11 GAMMA page 86
- 12 LAMBDA page 90
- 13 LHASA page 92
- 14 OMEGA page 94
- 15 ONION page 98
- 16 ORGANIC page 100
- 17 SIGMA page 102

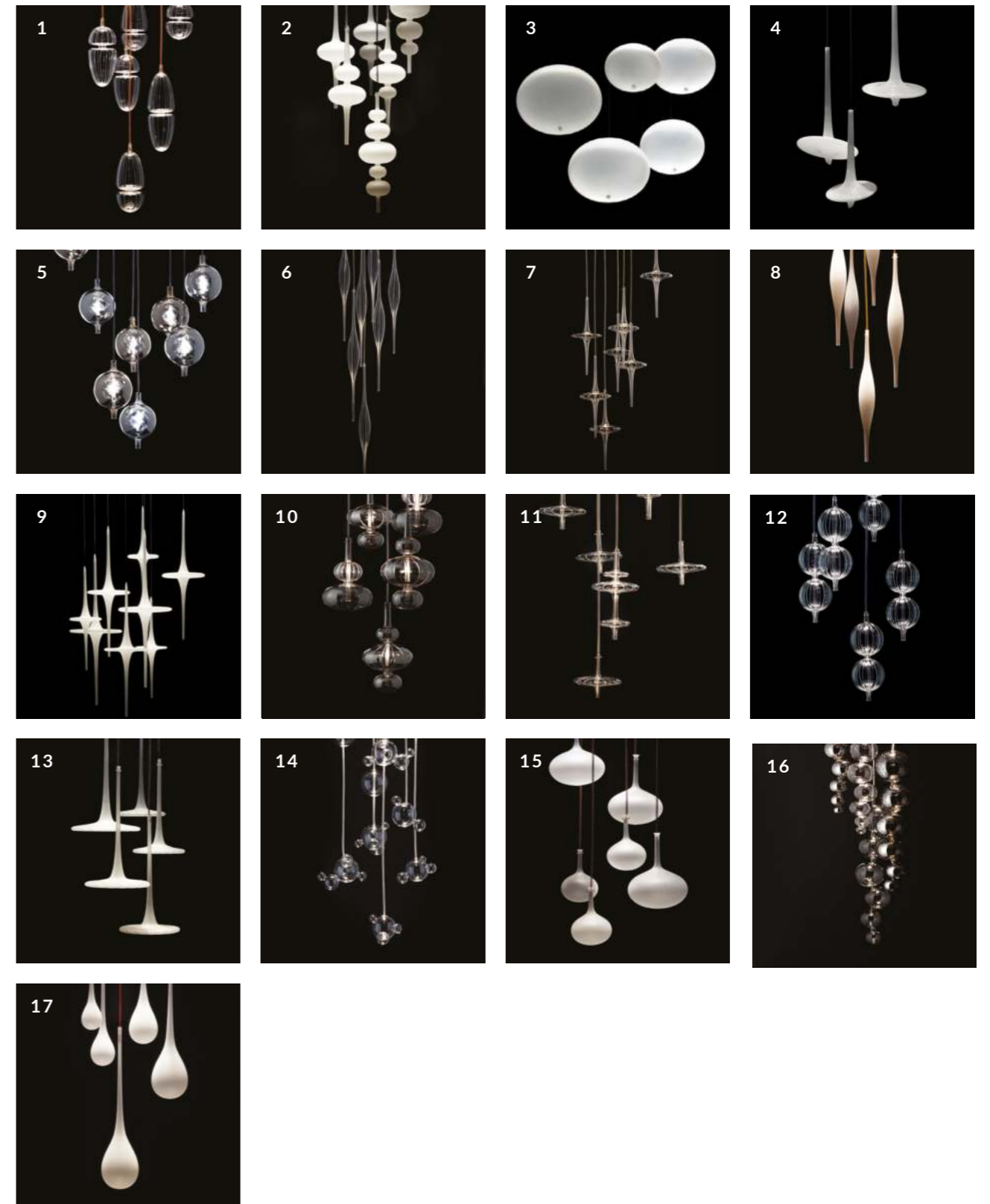

HYDRA

# ACORN

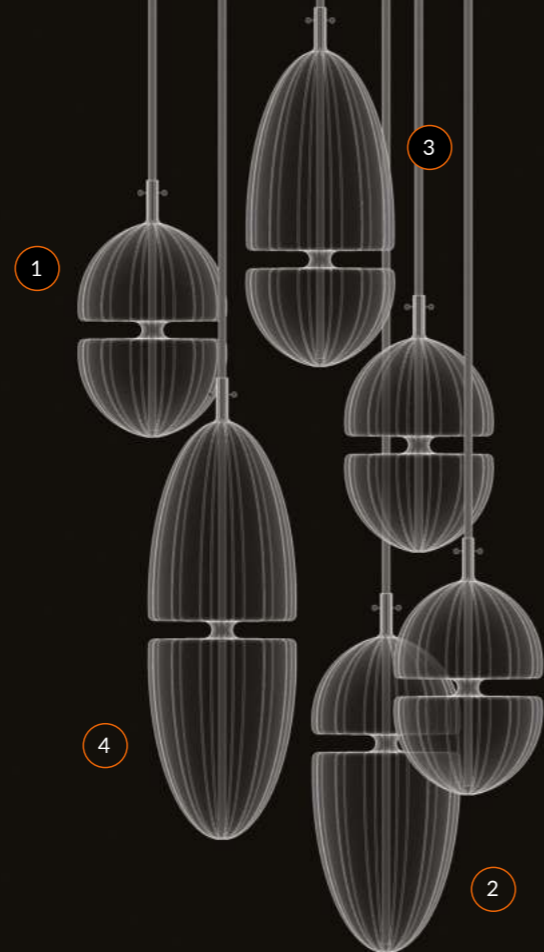

CLEAR OR FROSTED HAND-BLOWN RULED GLASS PENDANT.

4 shapes available: ① h. 21,5 - ø 12,5 cm. ② h. 30 - ø 12,5 cm. ③ h. 30 - ø 12,5 cm. ④ h 38,5 - ø 12,5 cm.





HYDRA

# ALPHA

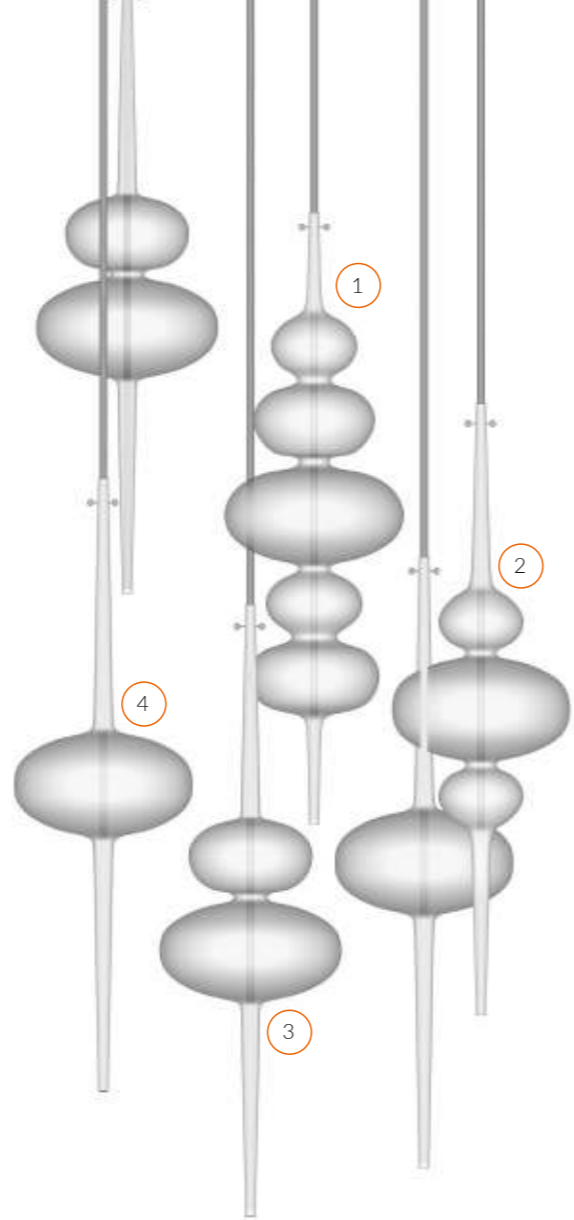

CLEAR OR FROSTED HAND-BLOWN GLASS PENDANT.

4 shapes available: ① h. 45 - ø 15,5 cm. ② h. 45 - ø 15,5 cm. ③ h. 45 - ø 15,5 cm. ④ h 45 - ø 15,5 cm.  
Additional inner light can be used with this model (see page 34).



HYDRA

# ACQUA

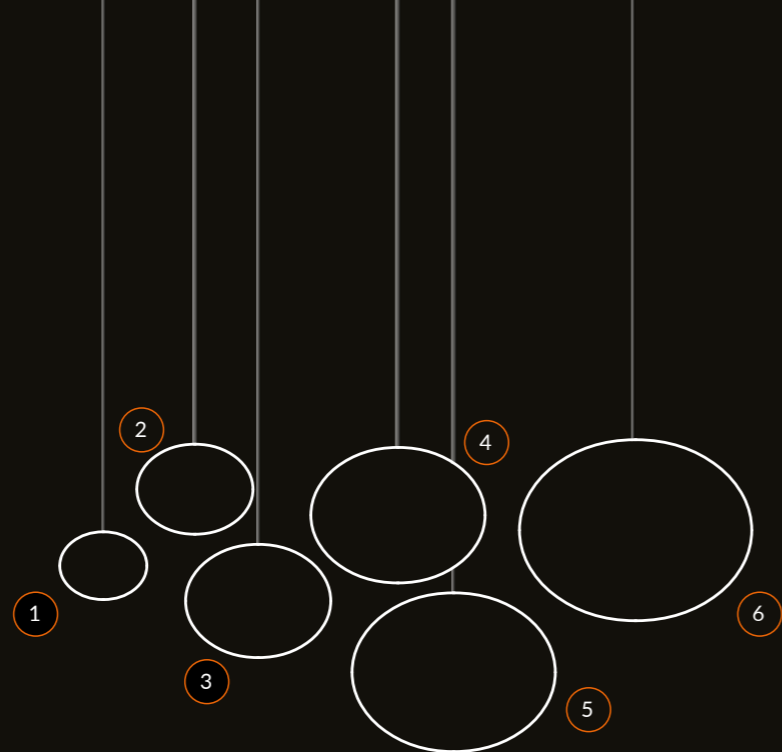

CLEAR OR FROSTED HAND-BLOWN GLASS PENDANT.

6 shapes available: ① ø 9 cm. ② ø 12 cm. ③ ø 15 cm. ④ ø 18 cm. ⑤ ø 21 cm. ⑥ ø 24 cm.



HYDRA

# AVATAR

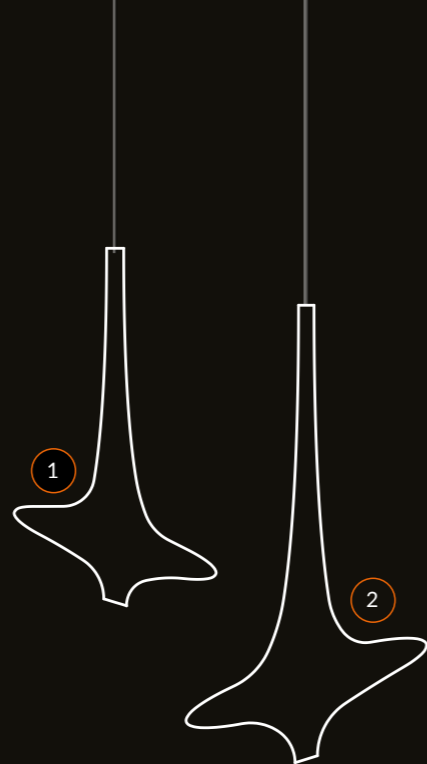

FROSTED OR METALLIZED GOLD HAND-BLOWN GLASS PENDANT.

2 shapes available: ① h. 23 - ø 13 cm. ② h. 29,5 - ø 15,5 cm.



HYDRA

# BERRY

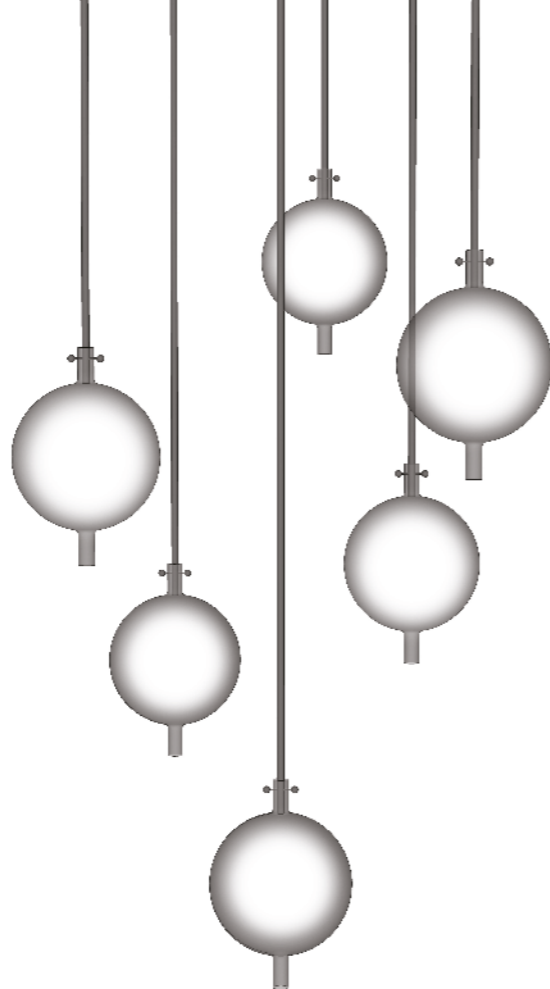

CLEAR HAND-BLOWN GLASS PENDANT.

One size only: h. 24 - ø 16 cm.



HYDRA

## BERRY METAL

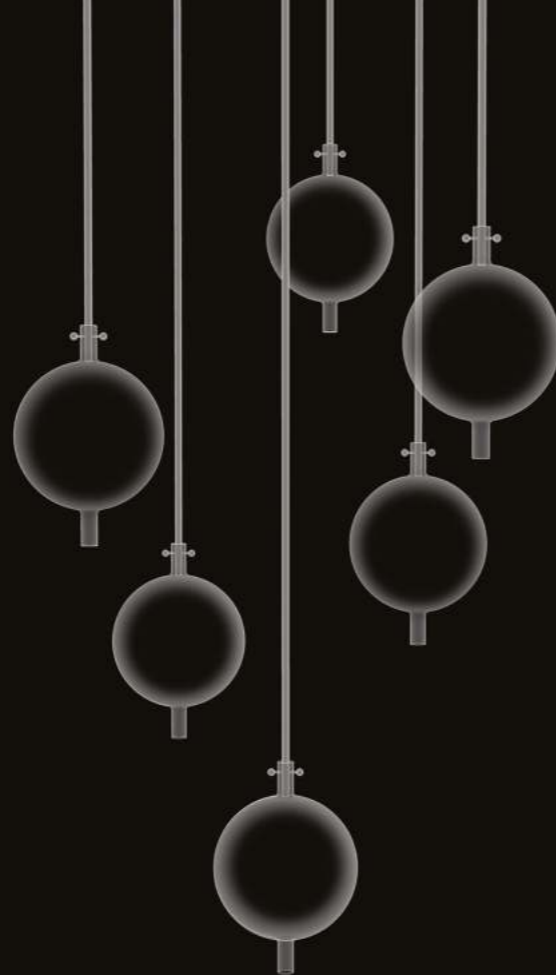

SILVER OR PINK GOLD METALLIZED HAND-BLOWN GLASS PENDANT.

One size only: h. 24 - ø 16 cm.

Additional inner light can be used with this model.





HYDRA

BETA

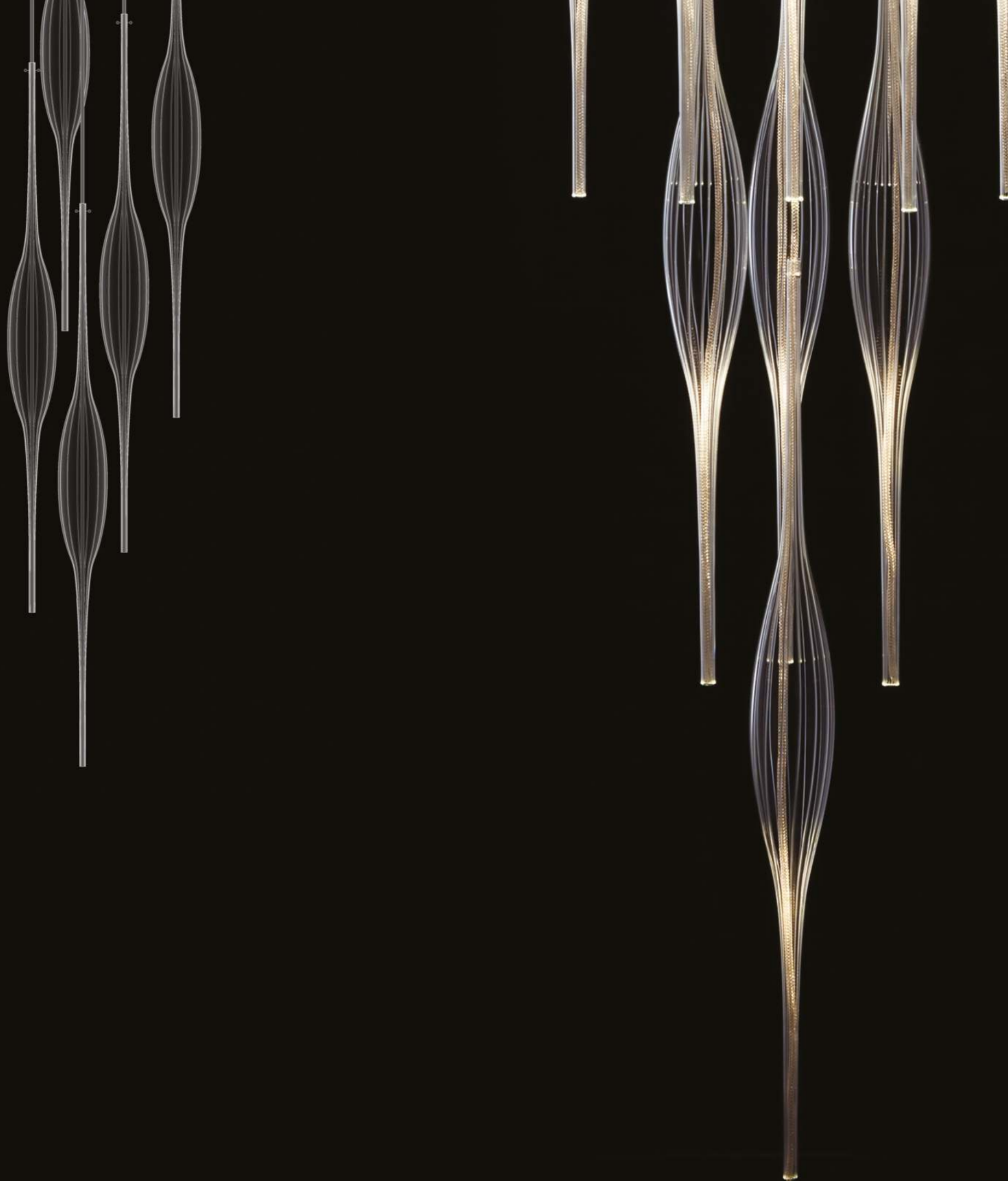

CLEAR OR FROSTED HAND-BLOWN RULED GLASS PENDANT.

One size only: h. 85 - ø 7,5 cm.

Additional inner light can be used with this model (see page 34).



HYDRA

# DATURA

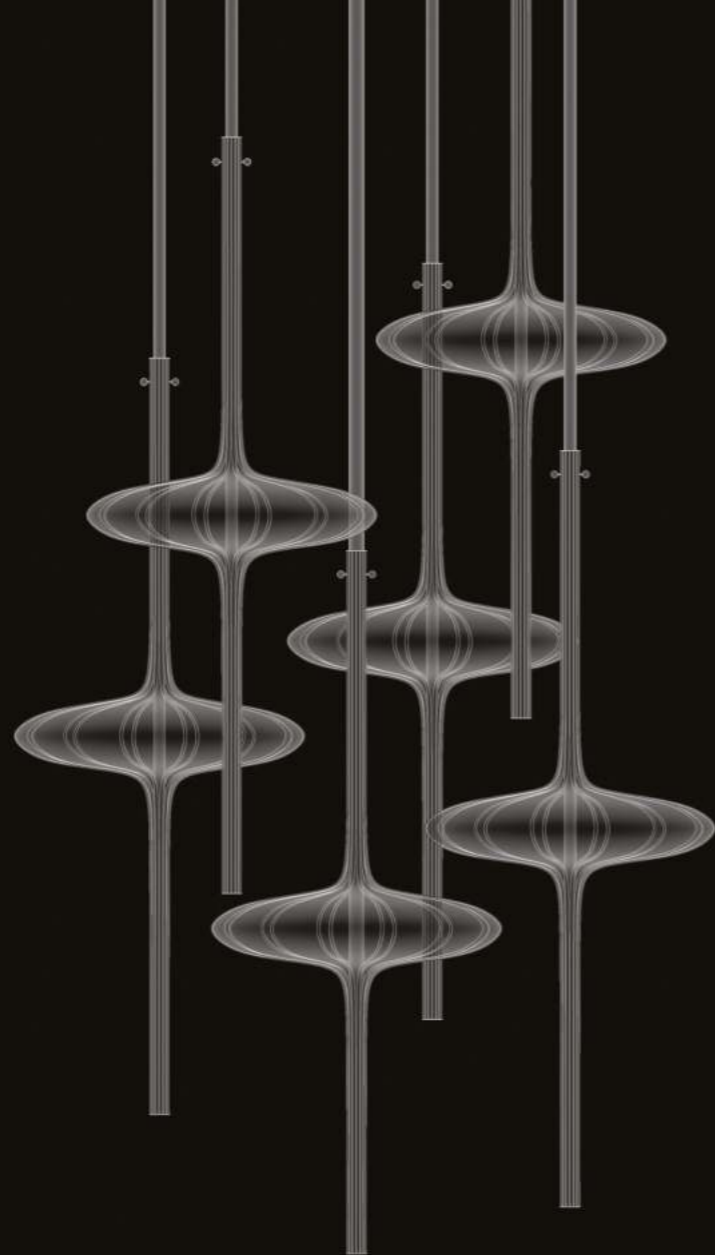

CLEAR OR FROSTED HAND-BLOWN RULED GLASS PENDANT.

One size only: h. 48 - ø 18 cm.

Additional inner light can be used with this model (see page 34).





HYDRA

# DELTA

FROSTED HAND-BLOWN GLASS PENDANT.

One size only: h. 50 - ø 6,5 cm.

Additional inner light can be used with this model (see page 34).



HYDRA

# DERVISCI

CLEAR OR FROSTED RULED BLOWN GLASS PENDANT.

3 shapes available: ① h. 38,5 - ø 12 cm. ② h. 48,5 - ø 16 cm. ③ h. 58,5 - ø 21 cm.

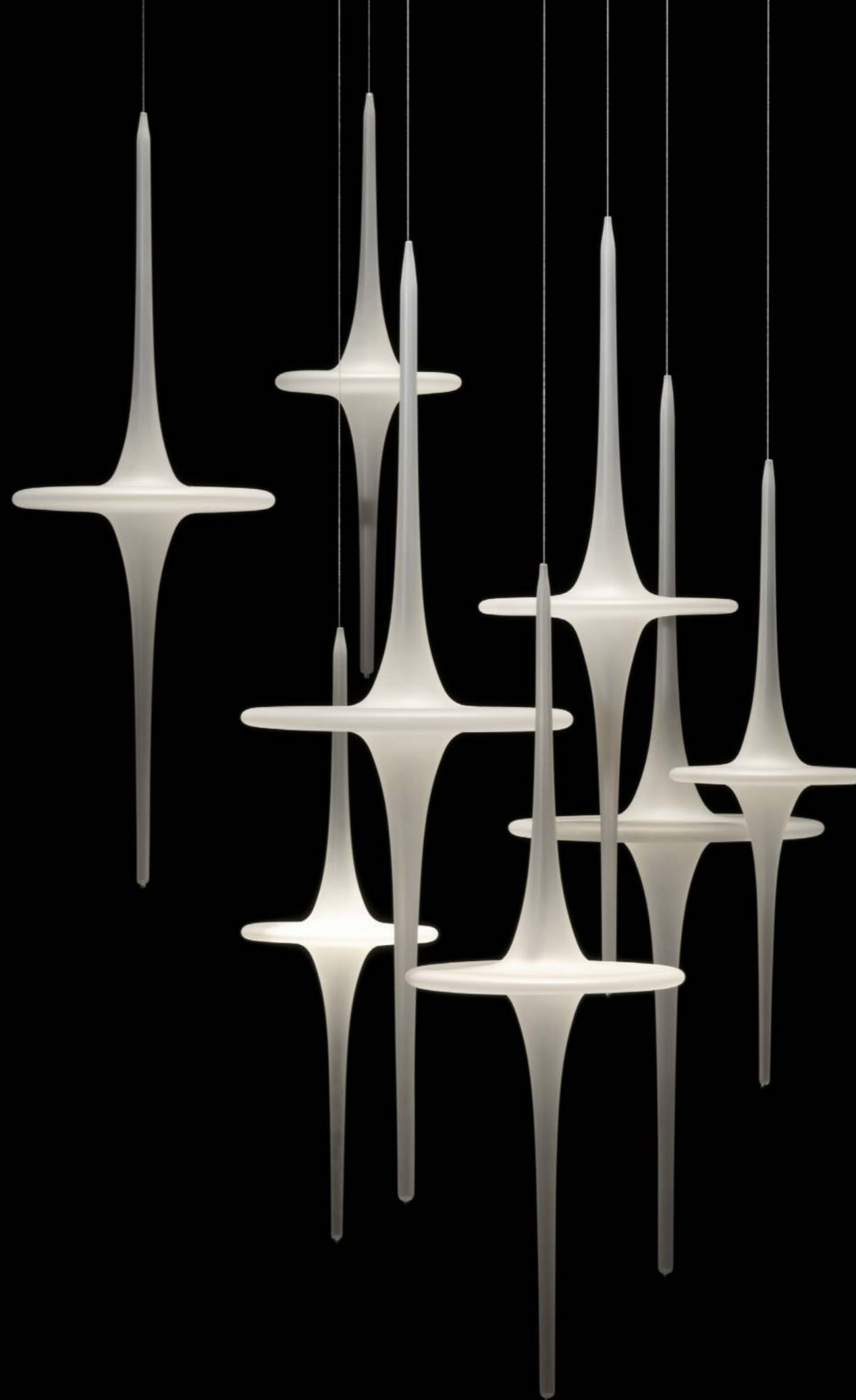

HYDRA

# DIESIS

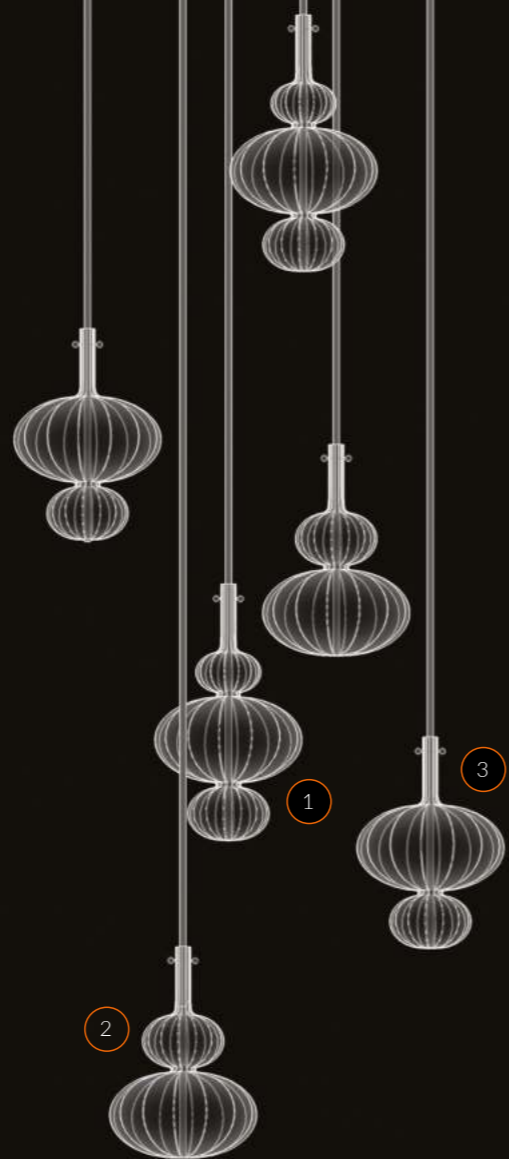

CLEAR, FROSTED OR METALLIZED HAND-BLOWN RULED GLASS PENDANT.

3 shapes available: ① h. 31 - ø 18 cm. ② h. 26 - ø 18 cm. ③ h. 26 - ø 18 cm.  
Additional inner light can be used with this model.



HYDRA

# GAMMA

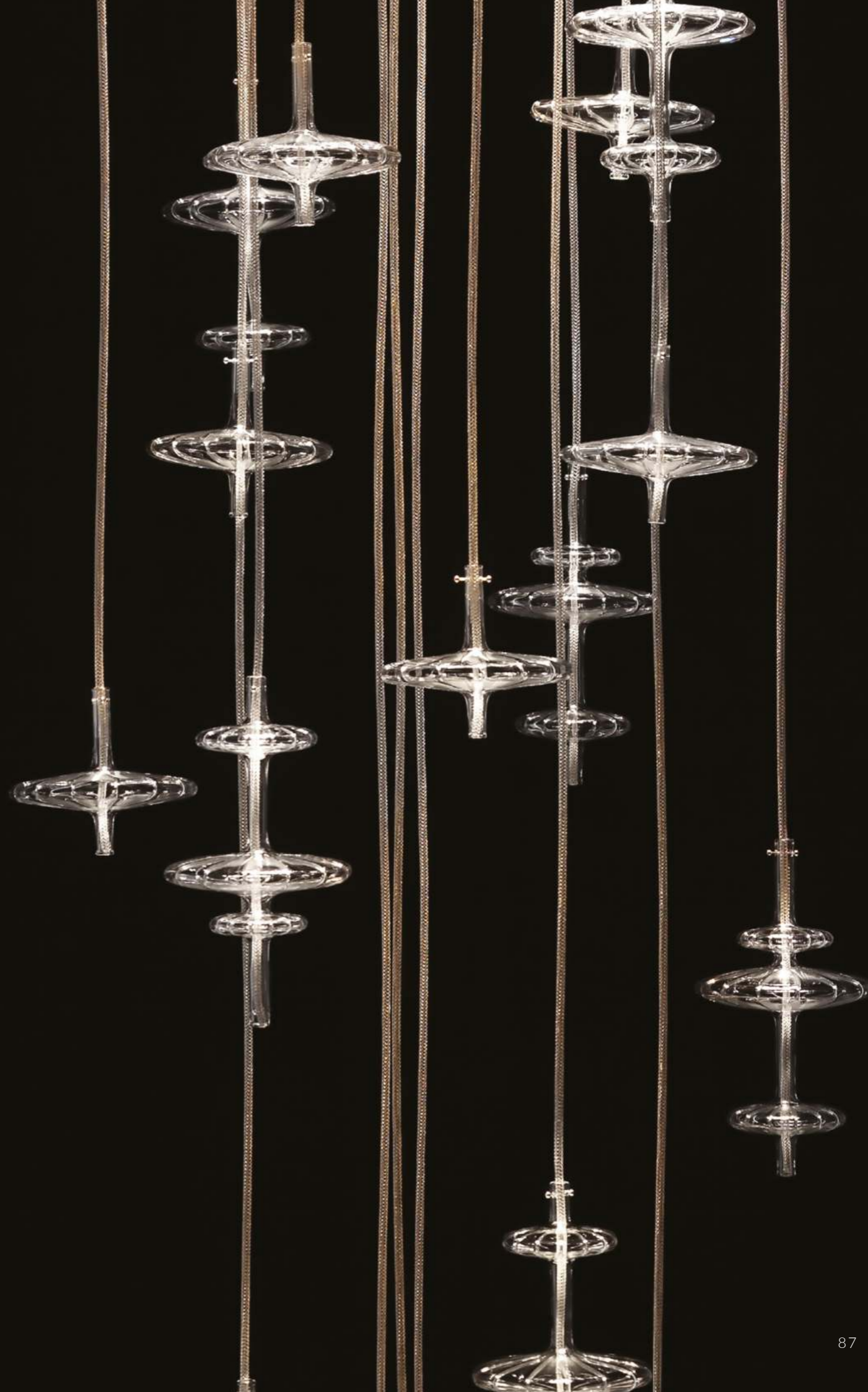
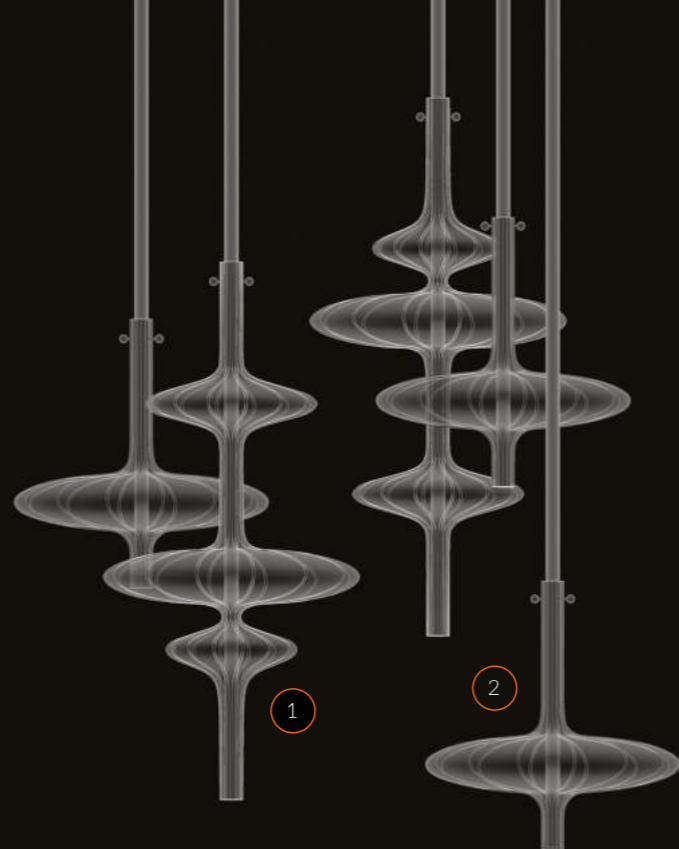

CLEAR HAND-BLOWN RULED GLASS PENDANT.

2 shapes available: ① h. 30 - ø 15 cm. ② h. 17 - ø 15 cm.

Additional inner light can be used with this model (shape ① only, see page 34).





HYDRA

# LAMBDA



CLEAR OR FROSTED HAND-BLOWN RULED GLASS PENDANT.

One size only: h. 31 - ø 10,5 cm.



HYDRA

# LHASA

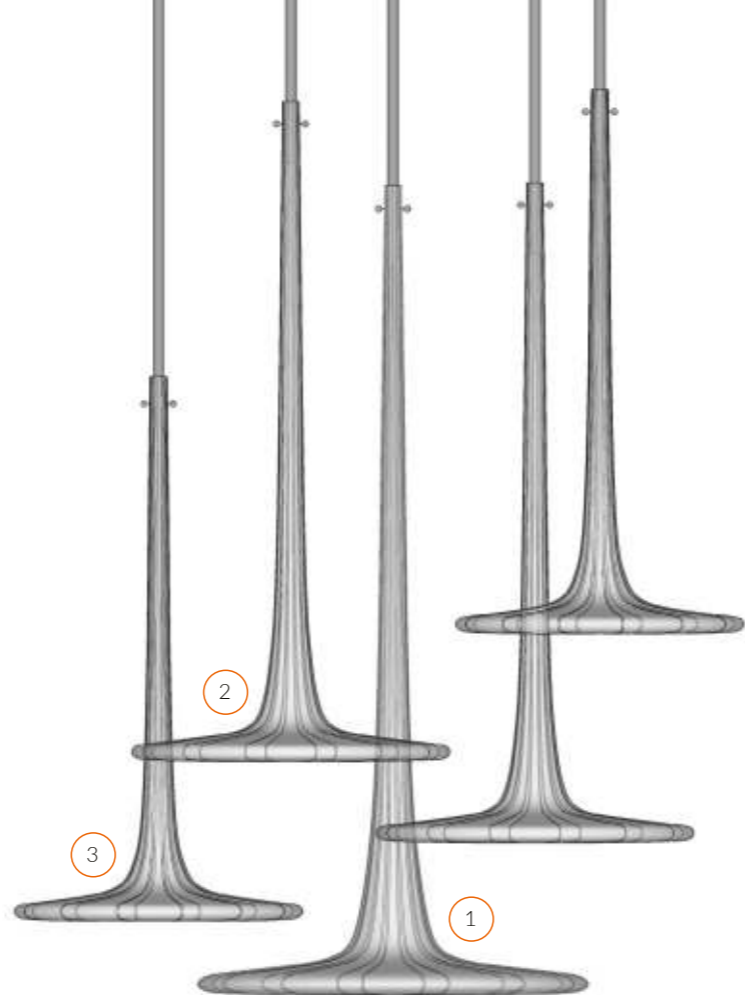

CLEAR OR FROSTED HAND-BLOWN RULED GLASS PENDANT.

3 sizes available: ① h. 56 - ø 27 cm ② h. 45 - ø 22 cm ③ h. 37 - ø 20 cm.



HYDRA

OMEGA

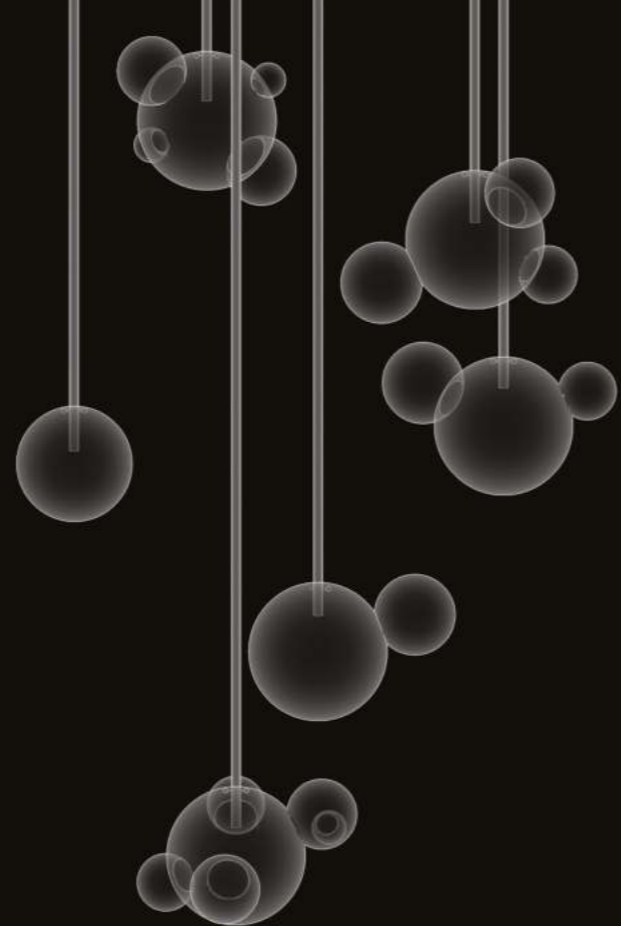

CLEAR HAND-BLOWN GLASS PENDANT.

8 shapes available. From  $\varnothing$  8 up to  $\varnothing$  23 cm.

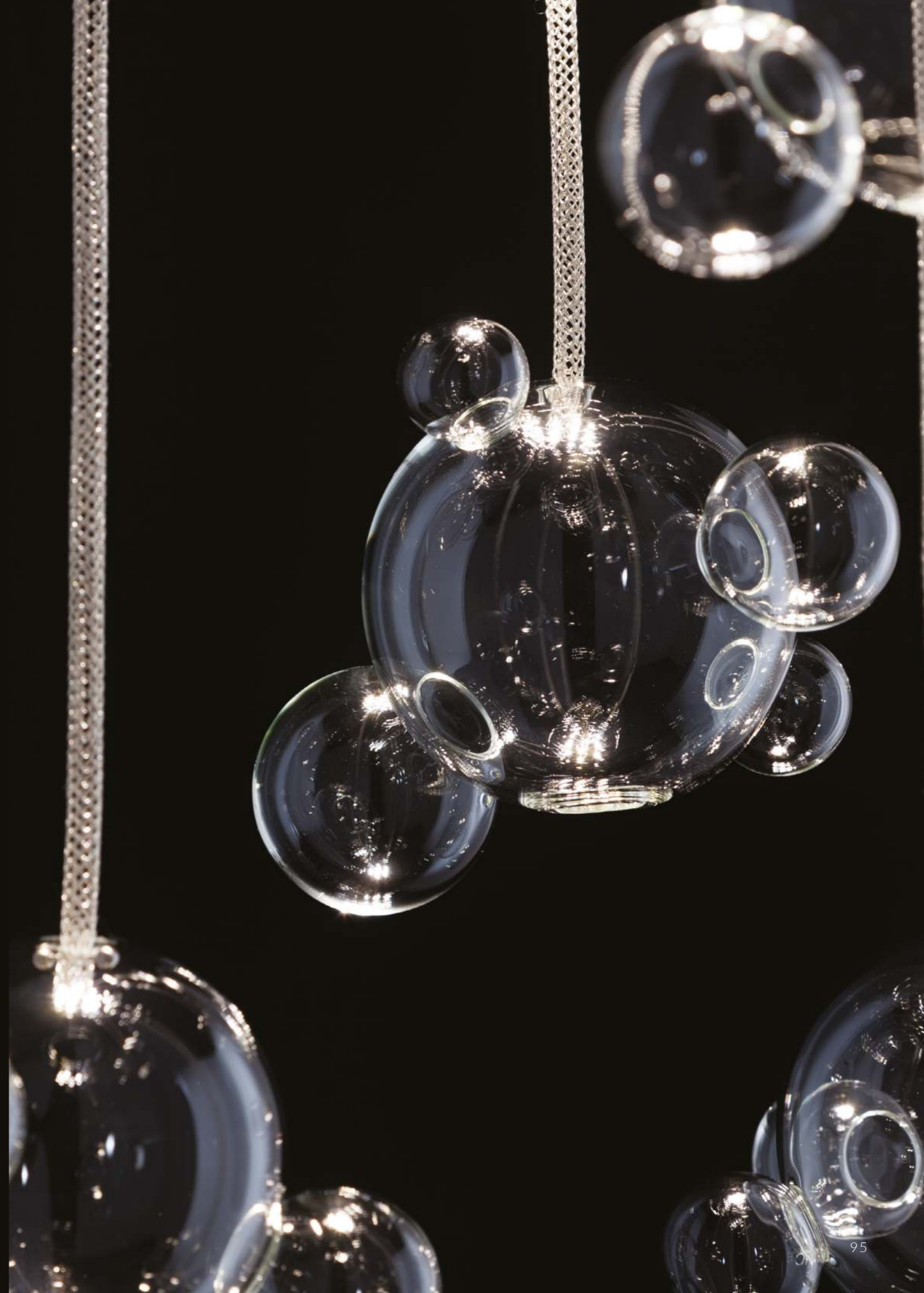





THE BEAUTY OF  
NATURAL IMPERFECTION

HYDRA

# ONION

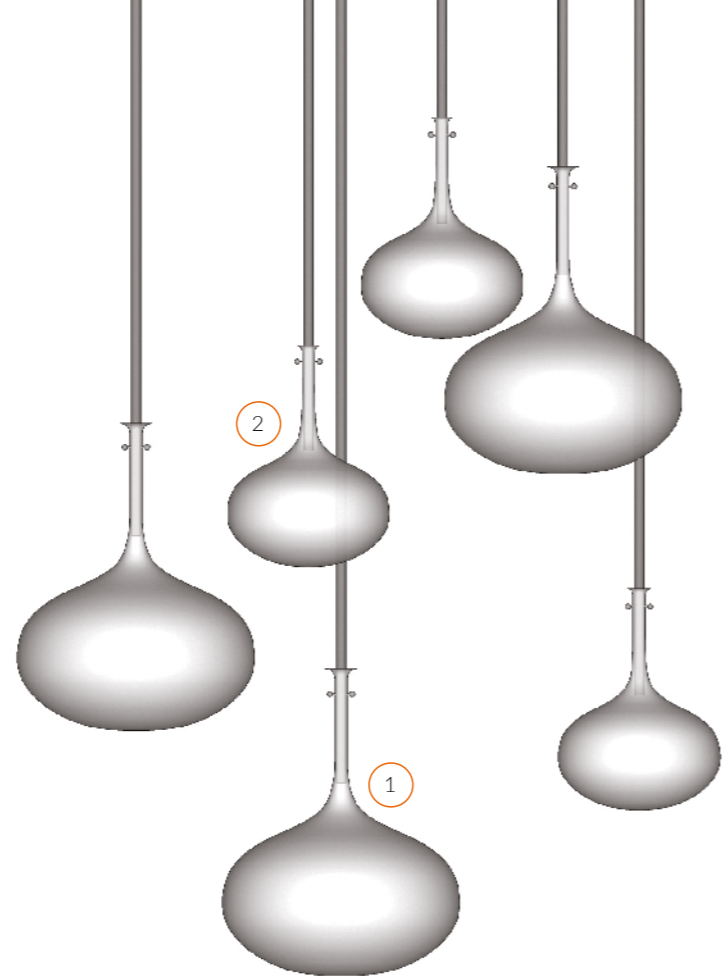

FROSTED HAND-BLOWN GLASS PENDANT.

2 sizes available: ① h. 25 - ø 19 cm. ② h. 18 - ø 13 cm.



HYDRA

# ORGANIC

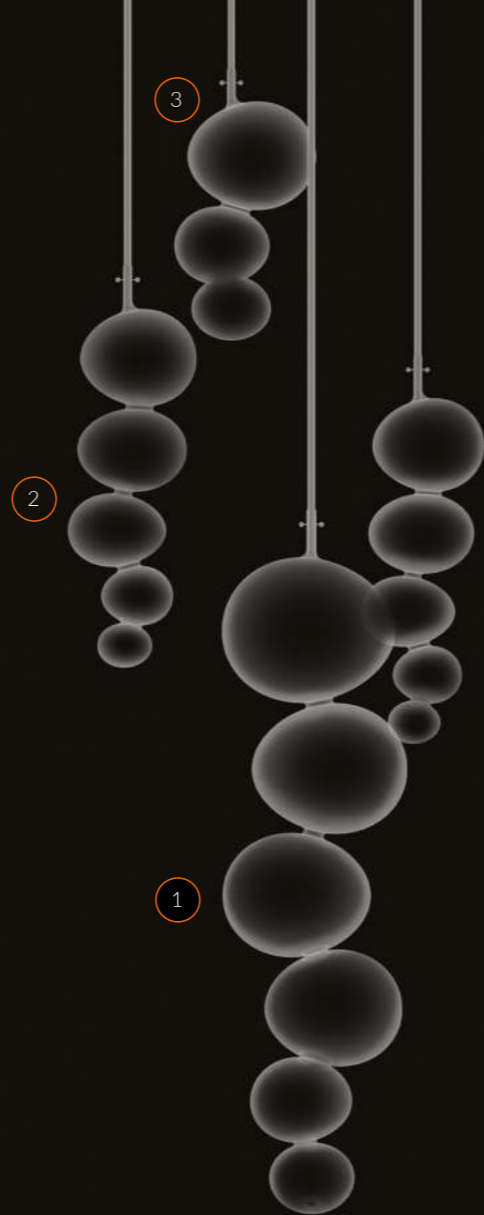

CLEAR OR METALLIZED HAND-BLOWN GLASS PENDANT.

3 shapes available: ① h. 70 - ø 18 cm. ② h. 50 - ø 15 cm. ③ h. 30 - ø 18 cm.



HYDRA

# SIGMA

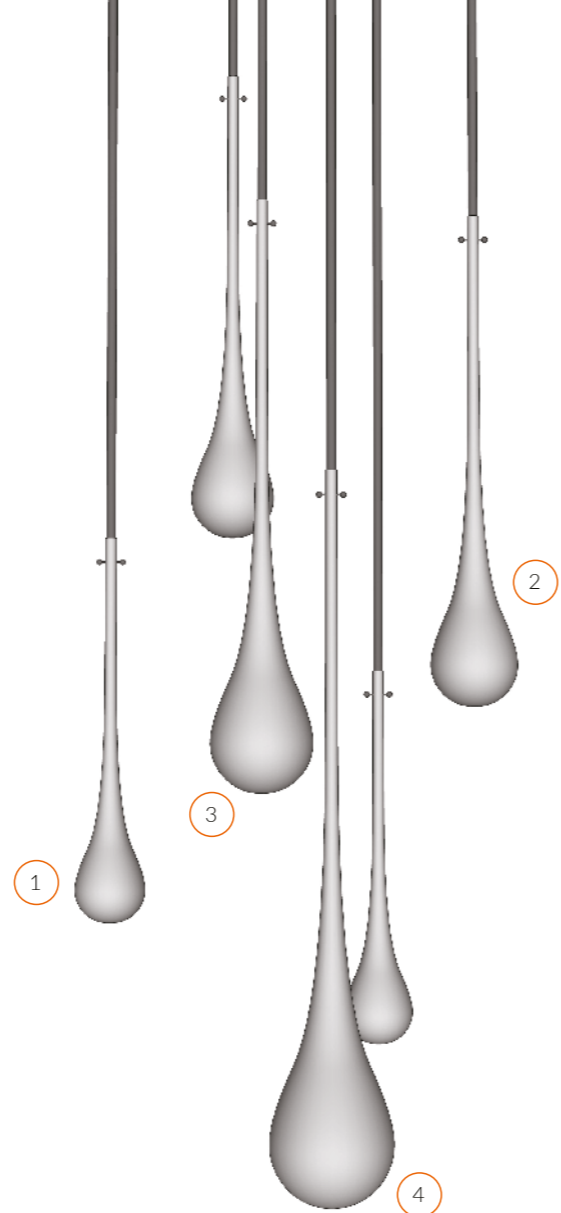

CLEAR OR FROSTED HAND-BLOWN GLASS PENDANT.

4 sizes available: ① h. 35 - ø 7 cm. ② h. 45 - ø 8 cm. ③ h. 55 - ø 9 cm. ④ h. 65 - ø 11 cm.



HYDRA SYSTEM

## LED CEILING LIGHTS

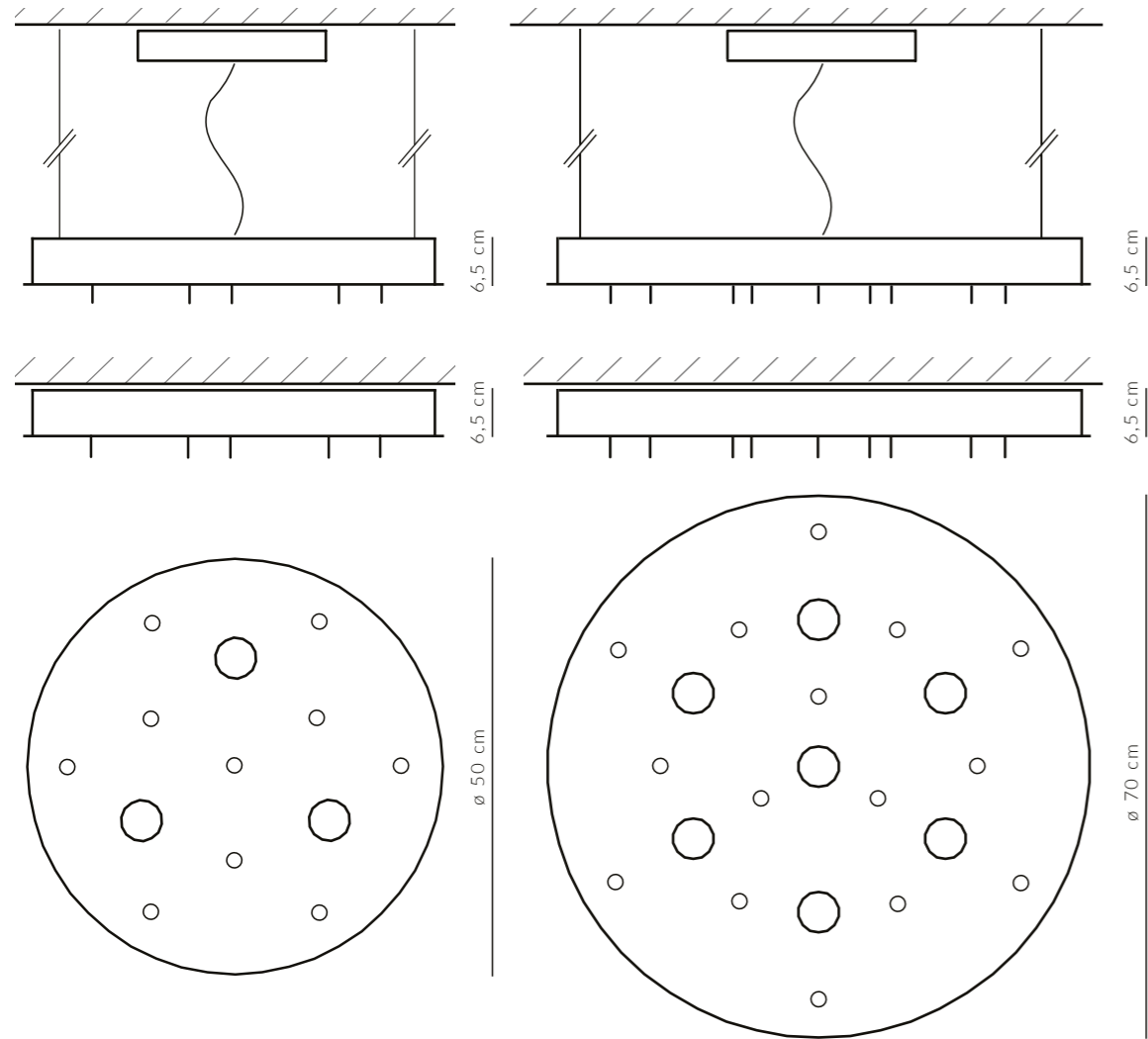

### ROUND METAL CEILING.

SMALL\_ø 50 cm. Varnished or mirror finishing.  
3 x 10W power LED dimmable, 2700k optic 10°.  
10 fixing supports for metallic mesh ropes.

LARGE\_ø 70 cm. Varnished or mirror finishing.  
7 x 10W power LED dimmable, 2700k optic 10°.  
15 fixing supports for metallic mesh ropes.

melogranoblu can design and produce customized ceiling lights.



# CREDITS

COPYRIGHT

© 2024 by melogranoblu srl



CATALOGUE DESIGN

BABOL COMMUNICATION  
[www.babolcommunication.com](http://www.babolcommunication.com)

